



High Performance BGA Cooling Solutions w/ superGRIP™ Attachment

ATS PART # ATS-X50330G-C1-R0

Features & Benefits

- » Designed for 33 x 33 mm BGA components
- » Requires minimal space around the component's perimeter; ideal for densely populated PCBs
- » Allows the heat sink to be detached and reattached without damaging the component or the PCB, an important feature in the event a PCB may need to be reworked
- » Strong, uniform attachment force helps achieve maximum performance from phase-changing TIMs
- » Eliminates the need to drill mounting holes in the PCB
- » Assembly comes standard with a high performance maxiFLOW™ heat sink which maximizes convection (air) cooling
- » Comes standard with clean break, reworkable, Chomerics T-766 phase change material

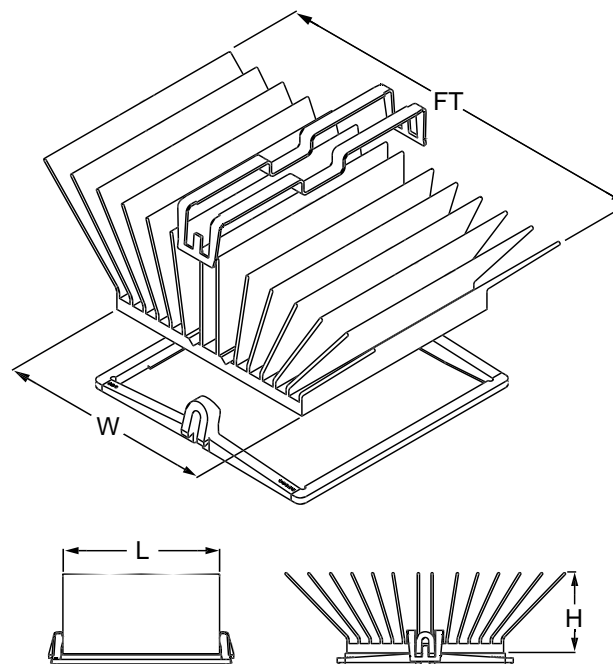

**Image above is for illustration purposes only.*

Thermal Performance

AIR VELOCITY		THERMAL RESISTANCE	
FT/MIN	M/S	°C/W (UNDUCTED FLOW)	°C/W (DUCTED FLOW)
200	1.0	3.5	2.7
300	1.5	2.8	
400	2.0	2.4	
500	2.5	2.1	
600	3.0	2	
700	3.5	1.8	
800	4.0	1.7	

Product Details

LENGTH	WIDTH	HEIGHT	FIN TIP to FIN TIP	INTERFACE MATERIAL	FINISH
33 mm	33 mm	12.5 mm	58.2 mm	CHOMERICS T766	BLUE-ANODIZED

NOTES:

- 1) Length and width dimensions refer to the size of the component. Dimensions of the heat sink are subject to tolerances of up to .99 mm in order to accommodate the clip assembly
- 2) Thermal performance data are provided for reference only. Actual performance may vary by application
- 3) ATS reserves the right to update or change its products without notice to improve the design or performance
- 4) Additional tooling fees may be required
- 5) Typical lead time is a minimum of 4-6 weeks
- 6) Contact ATS to learn about custom options available



ATS ADVANCED THERMAL SOLUTIONS, INC.
Innovations in Thermal Management®

For more information, to find a distributor or to place an order, visit www.qats.com or call: 781.769.2800 (North America); +31 (0) 3569 84715 (Europe).